



PYLONTECH

**M5 20FT Containerized
Battery Energy Storage System
Operation Manual**

Information Version: 1.0

Contents

1	Manual description	1
1.1	Scope of Application	1
1.2	Manual Use	1
1.3	Explanation of Symbols	1
1.4	Abbreviations Used	2
2	Safety	3
2.1	Symbols	4
2.2	Setting of Safety Warning Signs	7
2.3	Requirements for Escape Routes	7
2.4	Electrical Working	7
2.5	Moisture Protection	7
3	System Introduction	9
3.1	System Overview	9
3.2	Container	10
3.3	Battery String	10
3.3.1	Battery Module	11
3.3.2	Control Module	14
3.4	Electrical Cabinet	22
3.5	PCS	25
3.5.1	AC Switch	26
3.5.2	DC Switch	26
3.5.3	PCS Power Cable Connection	27
3.6	Fire-protection System	27
3.6.1	Agent fire extinguishing system	27
3.6.2	Fire Control Panel	30
3.6.3	Gas detection and ventilation system	30
3.6.4	Sprinkler System	31
3.7	Air Conditioning System	31
3.7.1	Main Interface	31
3.7.2	Password Input Interface	32
3.7.3	Running State	33
3.7.4	System Settings	33
4	System Installation	36
4.1	Installation Tools	36
4.2	Hoisting	36
4.3	Grounding	38
4.4	Door Opening	39
4.5	Fire-protection Preparation	39
4.6	Low-voltage Communication Installation	41
4.7	High-voltage Installation	42

- 4.7.1 Power Cables in the Cabinet 43
- 4.7.2 External Power Cable 43
- 4.8 HVAC Installation 45
- 5 System Commission..... 46**
- 5.1 System Status 46
- 5.2 System Startup 48
- 5.3 System Shutdown 52
- 6 Maintenance..... 56**
- 6.1 Trouble Shooting 56
- 6.1.1 System Troubleshooting 56
- 6.1.2 Battery String Failure 56
- 6.1.3 Fire Fighting Failure 57
- 6.1.4 Air Conditioner Failure 58
- 6.2 Emergency Disposal 60
- 6.2.1 EPO 60
- 6.2.2 Fire Fighting Equipment 60
- 6.3 Routine Maintenance 61

1 Manual description

1.1 Scope of Application

This manual is for the M5 20FT Containerized BESS (hereinafter referred to as "the system" unless otherwise noted).



This manual mainly provides users with detailed instructions for system installation, commission and maintenance.

Please read this manual before installing the system and follow the instructions carefully during installation. Any confusion, please contact Pylontech immediately for advice and clarification.

1.2 Manual Use

The content of this manual and the pictures, logos, symbols, etc. used in it are all owned by Pylon Technologies Co., Ltd. Non insiders of the company are not allowed to reprint part or all of the content without authorization. The content of the manual will be updated and revised constantly. If there is any discrepancy between the manual and the physical product, the user should take the purchased physical product as the standard.

1.3 Explanation of Symbols

Symbol	Description
	Danger Indicates a hazard with a high level of risk which, if not avoided, will result in death or serious injury.
	Warning Indicates a hazard with a medium level of risk which, if not avoided, could result in death or serious injury.
	Caution Indicates a hazard with a low level of risk which, if not avoided, could result in minor or moderate injury.

1.4 Abbreviations Used

Abbreviation	Designation
AC	Alternating Current
DC	Direct Current
SOH	Battery State of Health, in percent
SOC	State of Charge, in percent
BESS	Battery Energy Storage System
EMS	Energy Management System
BMS	Battery Management System
J-Box	High Voltage Box (Main Control Box)
PCS	Power Conversion System
Pylontech	Pylon Technologies Co., Ltd.
EU	European Union
DOD	Depth of Discharge
BMU	Battery Management Unit
MBMS	Master Battery Management System
UPS	Uninterruptible Power Supply
MCU	Microcontroller Unit
BESS	Battery Energy Storage System

2 Safety

The system only operated by authorized personnel. Read all safety instructions carefully prior to any work and follow these instructions at all times when working with the system.

Incorrect operation or work may cause:









- Injury or death to the operator or a third party;
- Damage to the system hardware and other properties belonging to the operator or a third party.









Skills of Qualified Personnel

Qualified personnel must have the following skills:

- Trained in the installation and commissioning of the electrical system, as well as the dealing with hazards;
- Knowledge of the manual and other related documents;
- Knowledge of the local regulations and directives.

2.1 Symbols

	<p>Danger</p>	<p>Lethal voltage!</p> <ul style="list-style-type: none"> ● Battery strings will produce high voltage DC power and can cause a lethal voltage and an electric shock. ● Only qualified personnel can wire the battery strings.
	<p>Warning</p>	<p>Risk of battery system damage or personal injury</p> <ul style="list-style-type: none"> ● DO not pull out the connectors while the system is working! ● De-energize all multiple power sources and verify that there is no voltage.
	<p>Caution</p>	<p>Risk of battery system failure or life cycle reduction.</p>
	<p>Symbol in label</p>	<p>Read the product and operation manual before operating the battery system!</p>
	<p>Symbol in label</p>	<p>Danger! Safety!</p>
	<p>Symbol in label</p>	<p>Warning electric shock!</p>
	<p>Symbol in label</p>	<p>Do not place near flammable material.</p>
	<p>Symbol in label</p>	<p>Do not connect the positive and negative reversely.</p>
	<p>Symbol in label</p>	<p>Do not be around open flame.</p>

	<p>Symbol in label</p>	<p>Do not place at the children and pet touchable area.</p>
	<p>Symbol in label</p>	<p>Recycle label.</p>
	<p>Symbol in label</p>	<p>Label for Waste Electrical and Electronic Equipment (WEEE) Directive (2012/19/EU).</p>
	<p>Symbol in label</p>	<p>The certificate label for EMC.</p>
 <p>Type Approved Safety Regular Production Surveillance www.tuv.com ID 0000000000</p>	<p>Symbol in label</p>	<p>The certificate label for Safety by TÜV Rheinland.</p>
	<p>Symbol in label</p>	<p>No burning</p>
	<p>Symbol in label</p>	<p>No Access Without Permission</p>
	<p>Symbol in label</p>	<p>Must wear safety helmet</p>
	<p>Symbol in label</p>	<p>Must wear ear protector</p>

--	--	--

2.2 Setting of Safety Warning Signs

During the installation, routine maintenance, overhaul and other operations of the system, to prevent irrelevant personnel from approaching and misoperation or accidents. Please observe the following:

- Obvious signs shall be set up at the front and rear switches of the maintenance equipment to prevent accidents caused by false closing
- Set up warning signs or safety warning tapes near the operation area.

2.3 Requirements for Escape Routes

To ensure that the staff can leave the site quickly in case of accident, please observe the following items:

In the process of equipment maintenance, overhaul and other operations, it is necessary to ensure that the escape routes are completely unblocked.

It is strictly prohibited to stack sundries in the escape way or occupy the escape way in any form.

2.4 Electrical Working

There is high voltage in the system, and accidental contact may lead to fatal electric shock danger, so when working with electricity, you should:

- Tag and lock the live area.
- Do a good job of protection, wear insulating gloves and shoes, and wear the corresponding level of anti-arc flashover clothing when necessary.
- There must be an escort to ensure personal safety.

2.5 Moisture Protection

The entry of moisture is very likely to damage electrical equipment! To ensure the normal use of various functions of the system, please observe the following items:

- Do not open the door of the system or equipment when the air humidity is above 95%.
- Avoid maintenance or overhaul of the system in rainy or humid weather conditions.

In addition, the following protective or emergency measures should be taken according to the needs of the site:

- During the maintenance and overhaul of the system, relevant personnel shall take appropriate protective measures according to the needs of the site, such as wearing anti-noise earplugs, insulating shoes, insulating gloves and scalding gloves.
- Take all necessary auxiliary measures to ensure the safety of personnel and equipment. Matters needing attention in the use of this manual:
- This manual cannot cover all possibilities during operation, maintenance and overhaul. Please contact our company in time if you encounter any situation that cannot be explained in the manual.
- In order to facilitate users to read and use this manual better, a large number of pictures are configured in the manual. All pictures are for illustration purposes only. Users should refer to the actual products received.

3 System Introduction

3.1 System Overview

This system is a high-voltage DC energy storage system based on lithium iron phosphate battery. The system adopts module series design, which can form all voltage platform systems within 1500V through standard 64V modules in series. Each group of high-voltage systems can also achieve the battery capacity required by users through parallel connection.

Through reliable BMS system and high-performance balancing technology, the whole system is characterized by flexible configuration and high reliability. It can be widely used in grid energy storage, photovoltaic energy storage, container energy storage, microgrid energy storage, data room and other application scenarios that need high-voltage platform batteries. The system application is shown in the following figure.

Product Application Scenario

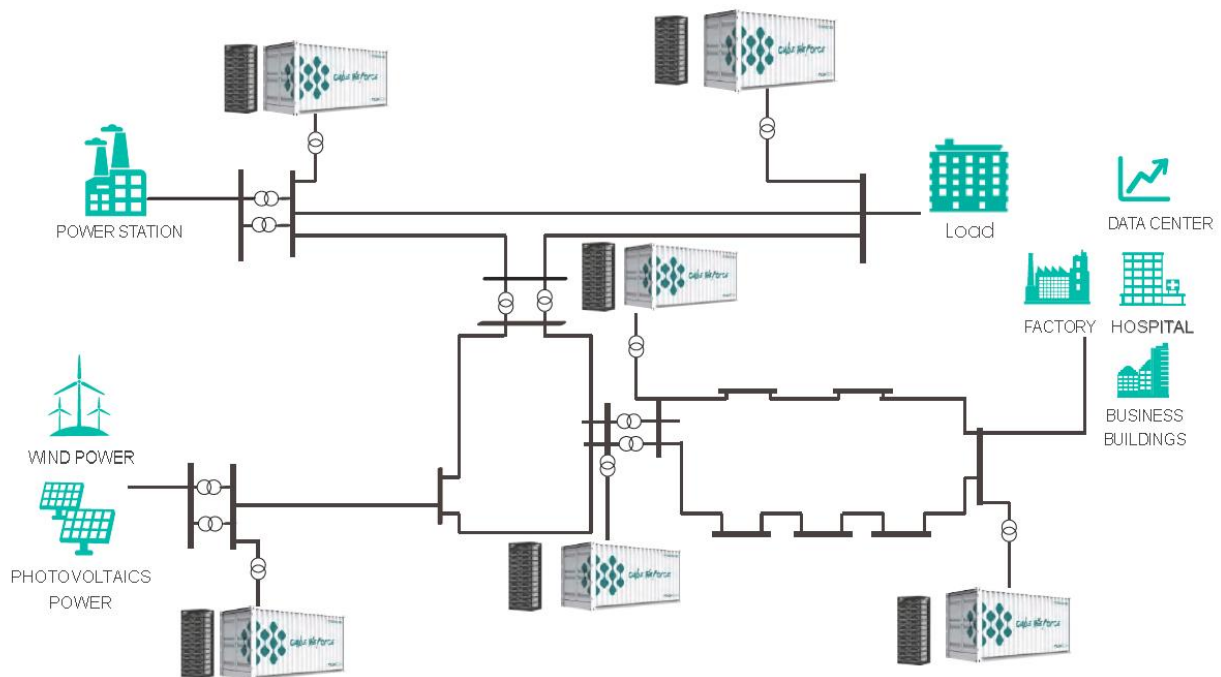

3.2 Container

The system adopts 20Ft standard container integration and external air conditioner at the same time. The layout of container system is shown in the following figure.

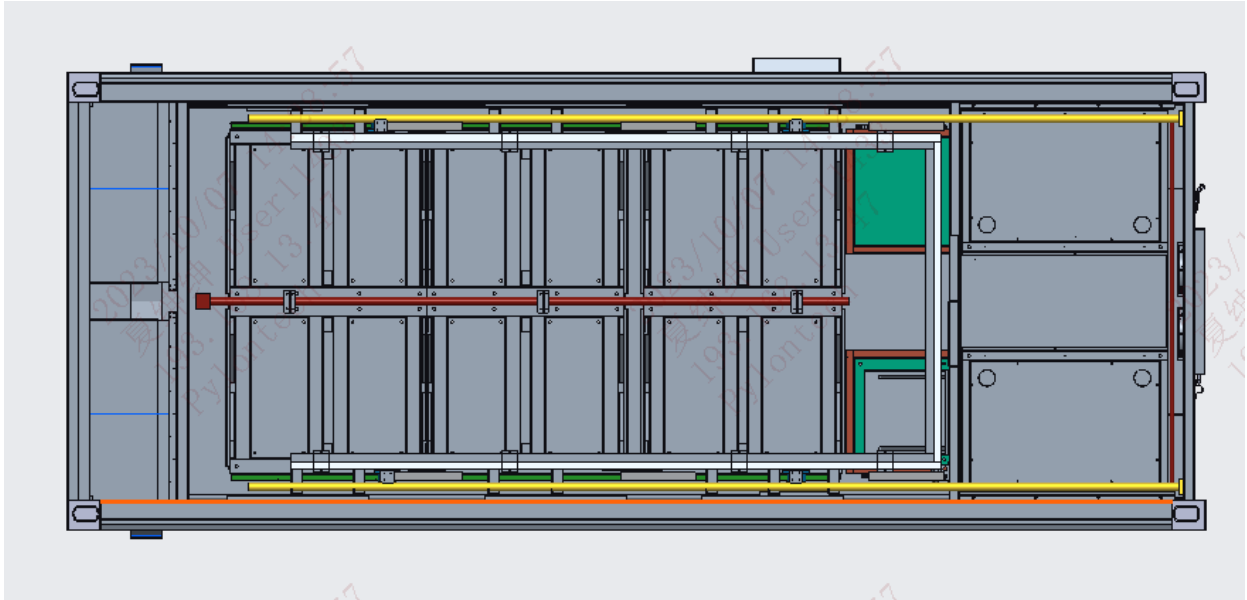

3.3 Battery String

The battery system consists of six 344.9 kWh battery cabinets. The appearance of the battery strings is shown in the following figure.

Exterior view of battery strings



3.3.1 Battery Module

Each battery string contains 11 battery modules in total. The appearance and the specification of the battery module are shown as follows.

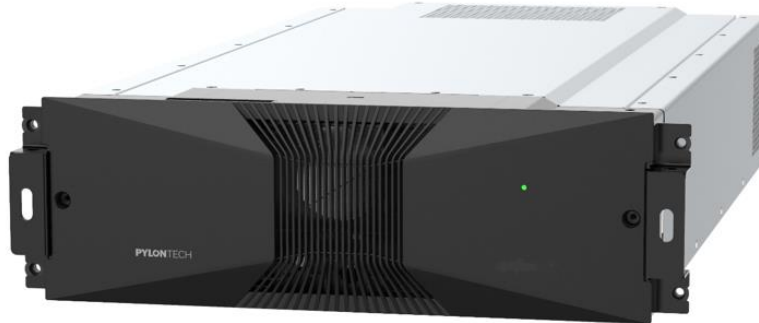

Product Type	HM5A180F
Cell Technology	LiFePO4 (LFP)
Battery Module Energy (kWh)	15.68
Battery Module Voltage (VDC)	64
Battery Module Capacity (Ah)	245
Power of BMU(W)	3
Power of Battery Module Fan (W)	15.6
Dimensions (W x D x H, mm)	515(W) x 935 (D) x 160.5(H)
Protection Class	IP20
Weight (kg)	115
Operation Cycle Life (cycle)*	>7,000
Operation Temperature(°C)	0 ~ 50
Storage Temperature(°C)	-20 ~ 50
Transportation Certificate	UN38.3

* Cycle life is defined based on specific operation conditions, for more details please check with Pylontech service team.

Battery Module (HM5A180F) Front Interface

Battery module with cover:

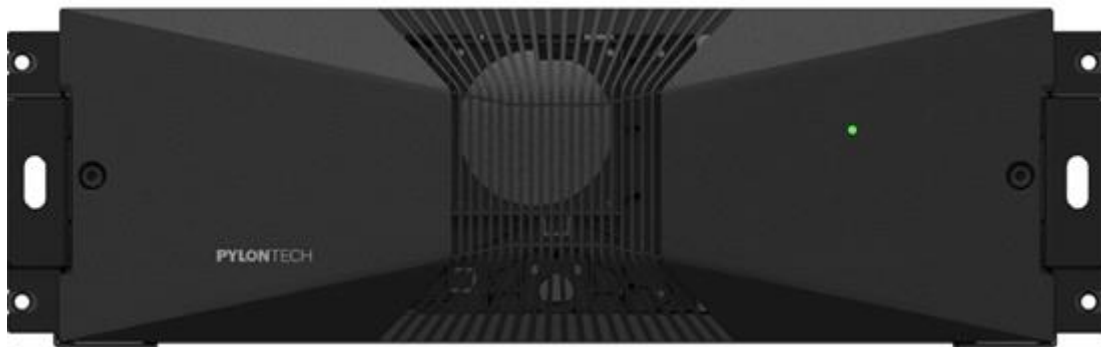

Battery module without cover:

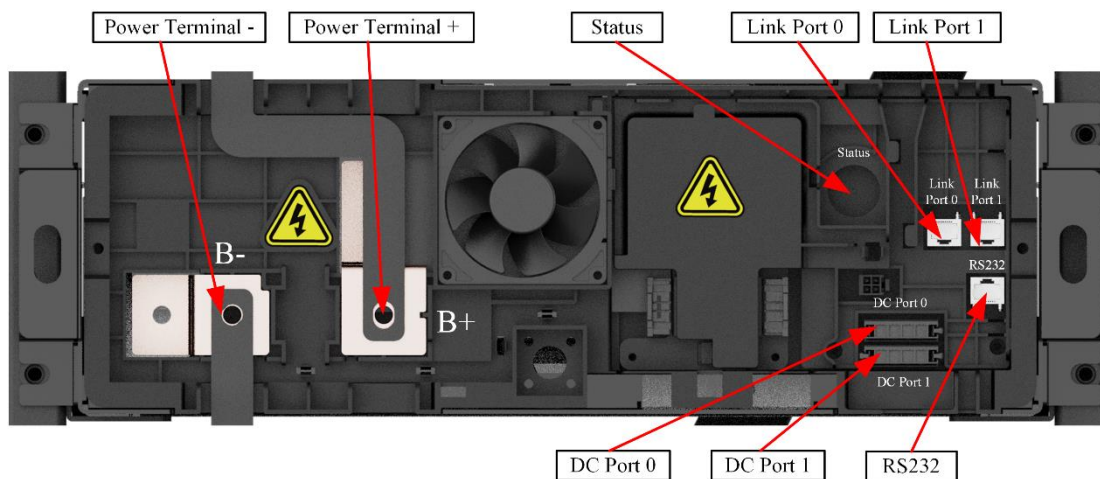

Power Terminal B+/B-

Connect battery in serial at power side.

Status

LED shows the battery module's status (Normal ●, Abnormal ●).

RS232 Terminal (RJ45 port)

Console Communication Terminal: follows RS232 protocol, for manufacturer or professional engineer to debug or service.

Link Port 0, 1 (RJ45 port)

CAN communication, between multiple serial battery modules and control module.

Definition of RJ45 Port Pin

No.	CAN	RS485	RS232
1	---	---	---
2	GND	---	---
3	---	---	TX
4	CANH	---	---
5	CANL	---	---
6	---	GND	RX
7	---	RS485A	---
8	---	RS485B	GND

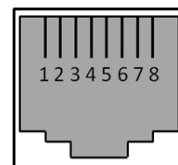

RJ45 Port

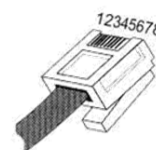

RJ45 Plug

DC Port 0, 1

The terminal is 4 pin of DC supply, which consists of 2 pins of 12V for BMU power supply, and 2 pins of 24V for fan power supply. DC Port 0 is use for DC power input. DC Port 1 is used for DC power output.

3.3.2 Control Module

Each battery string contains a control module. The appearance and the specification of the control module are shown as follows.



Product Type	S1500M5A180E
Related Product	M5A-180
AC Supply for BMS*	100~305 VAC/50/60Hz
Fan Power Consumption (W)	15.6 x n (where n = 1~21)
System Operation Voltage (VDC)	0~1500
Operation Current (Maximum) (A)	180
Self-consumption Power-Relay On (W)	16.5
Instantaneous power of relay engagement (W)**	65.4
Dimensions (W x D x H, mm)	460 (W) x 858 (D) x 160 (H)
Communication Protocol	RS485 (MODBUS RTU) \CAN \LAN
Protection Class	IP20
Weight (kg)	32
Operation Life (year)	15+
Operation Temperature (°C)	-20~65
Storage Temperature (°C)	-40~80

*AC power @100~305 VAC/50/60Hz supply to BMS and air fan separately.

** Instantaneous power consumption of each relay is 56.4W, which happens when relay acting.

Control Module Front Interface

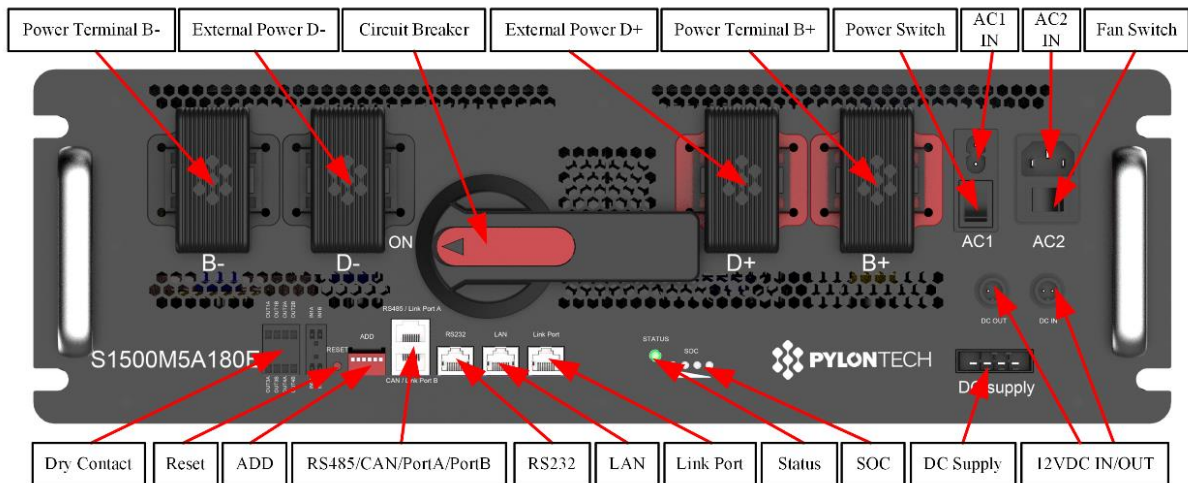

External Power Terminal D+/D-

Connect battery system to the PCS.

Power Terminal B+/B-

Connect to battery module in serial.

12VDC Output

OUT: Power supply for MBMS, to connect with MBMS' 12VDC IN.



12VDC Input

IN: Back-up 12 VDC power supply port for BMS.

DC Supply

Integrated with 12 VDC for BMU and 24 VDC for fans power supply, connects to battery module.

AC1 Input for BMS power supply

AC Socket and Control Module Power Switch: External power supply for Control Module, has Australia, Europe or U.S. standard AC Power input socket. Power Switch to control ON/OFF. Applied with UPS system. For the AC IN plug for BMS power supply, it is suggested to connect to UPS power supply.

Europe Standard

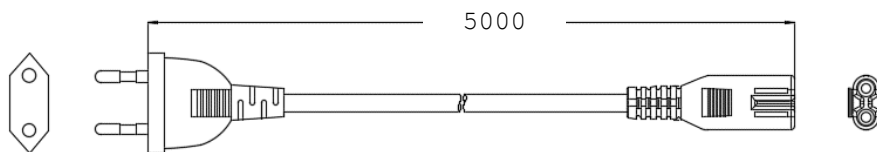

AC2 Input for FAN power supply

AC Socket and FAN Power Switch: There are Australia, Europe, UK and US standard AC power input sockets for external power supply. Power Switch to control ON/OFF. Fan power supply shall be connected to AC power grid. Refer to section 3.3.2 for fan power consumption.

Europe Standard

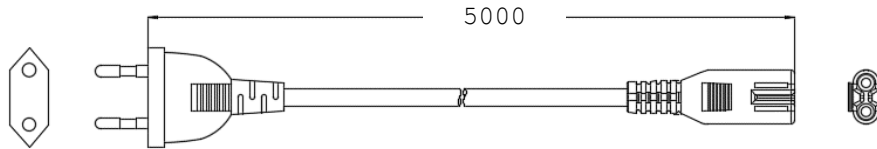

Power Switch

Controls the BMS power supply ON/OFF

Circuit breaker (S1500M5A180E)

Controls the Circuit breaker ON/OFF, and carries out shunt tripping function when system is overcurrent or short circuit.

FAN Switch

Controls the FAN power supply ON/OFF.

Dry Contact

Provides 2 input and 4 output dry contact signal.

Dry Contact Terminal:

In/out	Function	Open and close state
In1	Reserved	Always close.
In2	Emergency stop	Always close, power relay open when signal received.
Out1	Stop charging	Always close, when suggested charge current is "0" shall open.
Out2	Stop discharging	Always close, when suggested discharge current is "0" shall open.
Out3	Error	Always close, when system error activated shall open.
Out4	Current limit	Always close, when current limit $\leq 5A$ activated shall open.

Reset

Long press this button to restart the battery system.

ADD

ADD Switch is a 6 bit dial switch to manually distribute the communication address of the battery system.

Lower position is OFF, which means "0". Upward position is ON, which means "1".



1st to 5th bits are for address, and the 6th bit dial switch supports a 100Ω CANBUS terminal resistance.

RS485 / Link Port A

This communication terminal is RJ45 port, and the instructions are as follows:

RS485 (for external communication) follows Modbus RTU protocol, for communication between the battery system and the PCS.

Link Port A (for internal communication): used for cascade communication between the BMSs; when the system is configured less than 6 battery strings, it is used for communication between the first battery string's BMS and the MBMS.

CAN / Link Port B

This communication terminal is RJ45 port, and the instructions are as follows:

CAN (for external communication) follows CAN protocol, for communication between the battery system and the PCS.

Link Port B (for internal communication): used for cascade communication between the BMSs.

RS232

Console Communication Terminal: (RJ45 port) follows RS232 protocol, for manufacturer or professional engineer to debug or service.

LAN

Console Communication Terminal: (RJ45 port) follows Modbus TCP protocol, only used for communication between the master control module and upper controller.

Link Port

Link Port Communication Terminal: (RJ45 port) for internal communication between multiple serial battery modules and control module.

Definition of RJ45 Port Pin

No.	CAN	RS485	RS232
1	---	---	---
2	GND	---	---
3	---	---	TX
4	CANH	---	---
5	CANL	---	---
6	---	GND	RX
7	---	RS485A	---
8	---	RS485B	GND

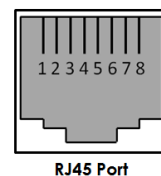

Status

Status LED: shows the battery module's status (RUN●, Alarm and Protection●).

SOC

Battery capacity indicators: 4 green lamps, each light represents 25% capacity.

LED Indicators Instructions

Battery Status	Protection / Alarm / Normal	STATUS (green)	STATUS (red)	Capacity SOC				Descriptions
		●	●	●	●	●	●	
Shut Down		Off	Off	Off	Off	Off	Off	All off
Sleep	Normal	Flash 1	Off	Off	Off	Off	Off	Indicates Sleep Mode, to save the power.
Idle	Normal	Light	Off	Off	Off	Off	Off	Indicates save power mode.
	Alarm	Light	Off	Off	Off	Off	Off	Indicates the battery voltage or temperature is high or low.
	Protection	Off	Light	Off	Off	Off	Off	Indicates the battery voltage or temperature is over or under.
Charge	Normal	Light	Off	The highest capacity indicator LED flashes (Flash 2), others lighting, horse race lamp when SOC >= DODH;				The highest capacity indicator LED flashes (flash 2), others lighting, horse race lamp when SOC >= DODH;
	Alarm	Light	Off					
	Protection	Off	Light	Off	Off	Off	Off	Stop charging, STATUS (red) lighting
Discharge	Normal	Flash 1	Off	Indicate based on capacity				Indicate based on capacity
	Alarm	Flash 1	Off					
	Protection	Off	Light	Off	Off	Off	Off	Stop discharging, STATUS (red) lighting
Abnormal	Power On Fault	Off	Flash 2	Off	Off	Off	Off	Stop charging/discharging, STATUS (red) lighting
	Other Fault	Off	light	Off	Off	Off	Off	

	STL Fault	Off	Flash 1	Flash 1	MCU self-check problem
--	--------------	-----	------------	---------	---------------------------

The flashing instructions:

Flash 1 - 0.5 s light / 0.5 s off;

Flash 2 - 1s light / 1 s off.

3.4 Electrical Cabinet

The arrangement structure of the electrical cabinet is shown in the following figure.



The electrical cabinet contains UPS, MBMS, micro breaks, and secondary electrical schematic diagram is shown in the following figure.

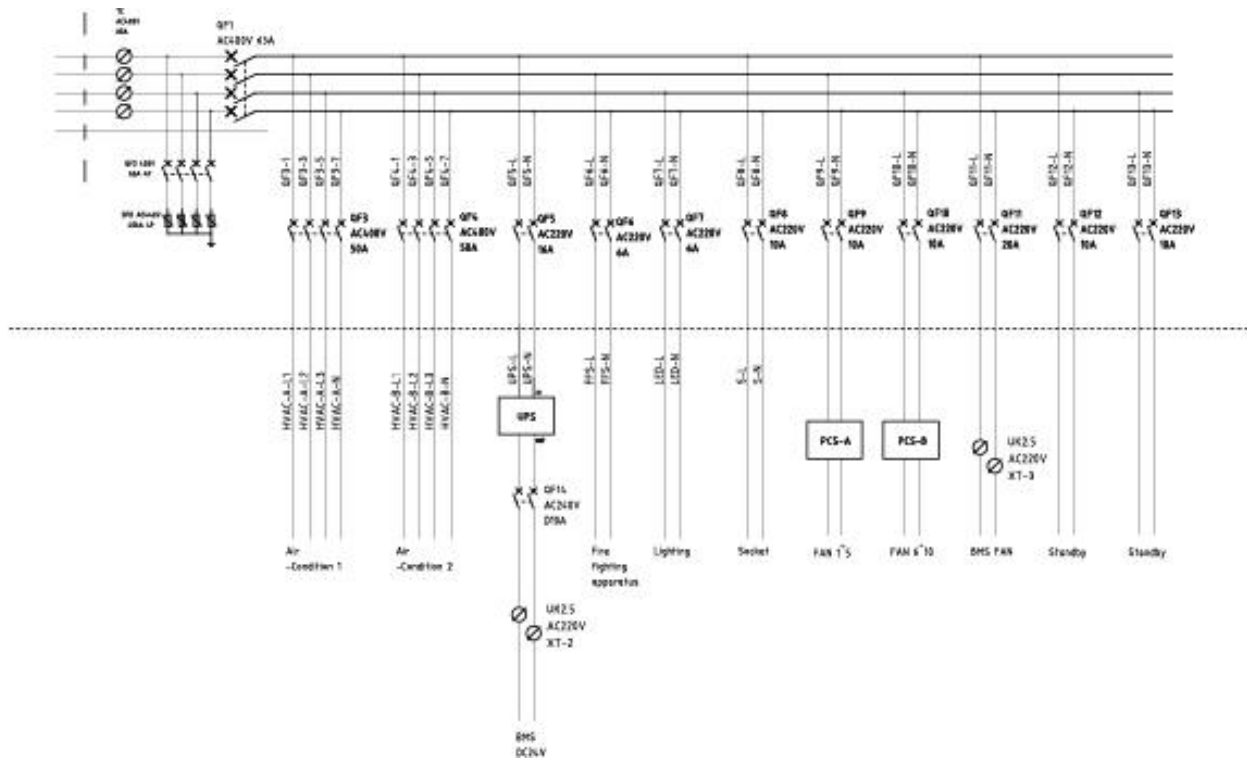

UPS

The electrical cabinet is equipped with UPS to supply power for computers, BMS, control cabinet secondary, power distribution cabinet ammeter and other loads, so as to ensure that the system can still operate for a period of time in case of mains power failure, and realize the system off grid operation. The specific operations are as follows:

- After the container is transported to the site, first connect the cable in the following figure to the terminal of the UPS, connect the orange cable to the orange terminal, and connect the black cable to the black terminal.
- Turn on the US2000C boat-type switch.
- Turn the power button of the UPS to ON for about 3 seconds, and observe the indicator light of the UPS host. If there is mains power, the indicator light is green, indicating normal startup.

Note: When you need to shut down the UPS, turn the Power button to OFF and observe the UPS LED light. If it is off, the UPS is shut down.



MBMS (Level III)

Master Battery Management System (MBMS) includes data acquisition and communication. Alarm and protection, control, energy state estimation, equalization, insulation monitoring and other functions.

The MBMS in the electrical cabinet is a three-level battery management system, which collects the information of each string, summarizes and communicates with PCS and EMS.



3.5 PCS

Bidirectional energy storage converter Bidirectional energy storage converter is a conversion device between the power grid and the battery, which can charge and discharge the battery. The direct current from the battery can be inverted into the alternating current that can be connected to the power grid, and the alternating current of the power grid can also be rectified into the direct current that can be charged into the battery. The bidirectional energy storage converter can be used in grid connection mode or off grid mode.

External switch cabinet is optional to realize fast switching between grid connection and off grid modes. Single stage topology is adopted, and the voltage input range is wide: 600-900V. PCS detail drawing and layout table are shown in the following chart.

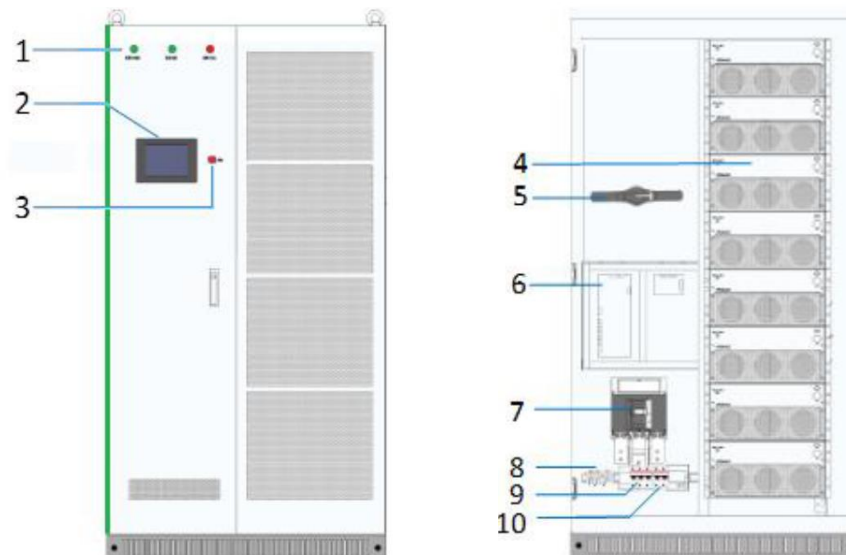

No.	Designation
1	Indicator light
2	Touch screen
3	Emergency stop switch
4	PCS-AC power module
5	Battery DC branch switch
6	U2 main control board
7	AC switch

8	Terminal blocks
9	Surge protector switch
10	Auxiliary power supply switch

3.5.1 AC Switch

The AC switch is used to disconnect the PCS from the power grid.

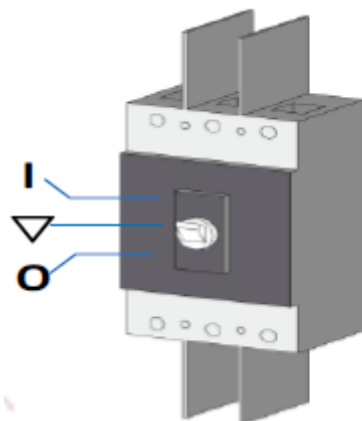

Position	Designation	Description
I	Closing position	AC switch on
∇	Tripping position	AC switch tripping
O	Opening position	AC switch off

3.5.2 DC Switch

The DC switch is used to disconnect the battery from the PCS.

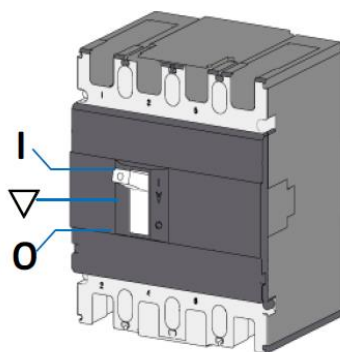

Position	Designation	Description
I	Closing position	DC switch on
∇	Tripping position	DC switch tripping
O	Opening position	DC switch off

3.5.3 PCS Power Cable Connection

The bidirectional energy storage converter adopts a bottom in and bottom out wiring method, and the cable is vertically inserted into the cable trench through the wire hole on the base. Open the front door and remove the inner door baffle to see the wiring copper bar. For the requirements of connecting cables, single or multiple cables with appropriate wire diameters should be selected, and it is recommended that the current on a 1mm² wire be ≤ 3A.

After opening the front door and removing the inner door baffle the copper connections is shown in the following figure.

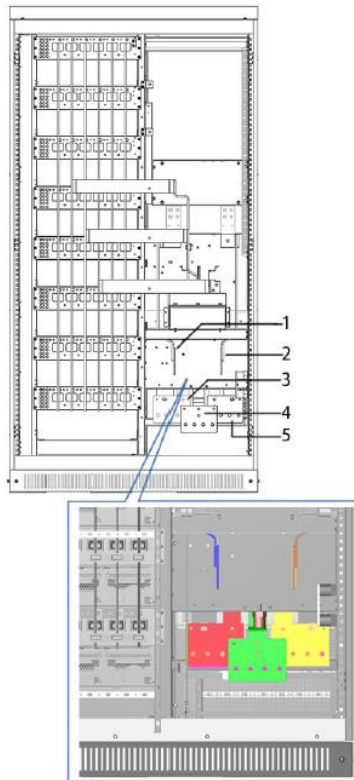

No.	Designation	Description
1	Battery -	Battery negative terminal
2	Battery +	Battery positive terminal
3	Grid C phase	C phase
4	Grid B phase	B phase
5	Grid A phase	A phase

3.6 Fire-protection System

3.6.1 Agent fire extinguishing system

The agent fire extinguishing system is mainly composed of agent fire extinguishing system and agent release control system. The agent release control system is composed of heat detector, manual button, smoke detector, Horn strobe, bell, Gas release indication, manual automatic transfer box (including mode select keyswitch & manual release surface) etc. The agent fire extinguishing system consists of

agent cylinder, Container Valve, pressure switch, pipe, cabinet, nozzle, etc.

The control logic of the fire protection system is shown in the following figure.

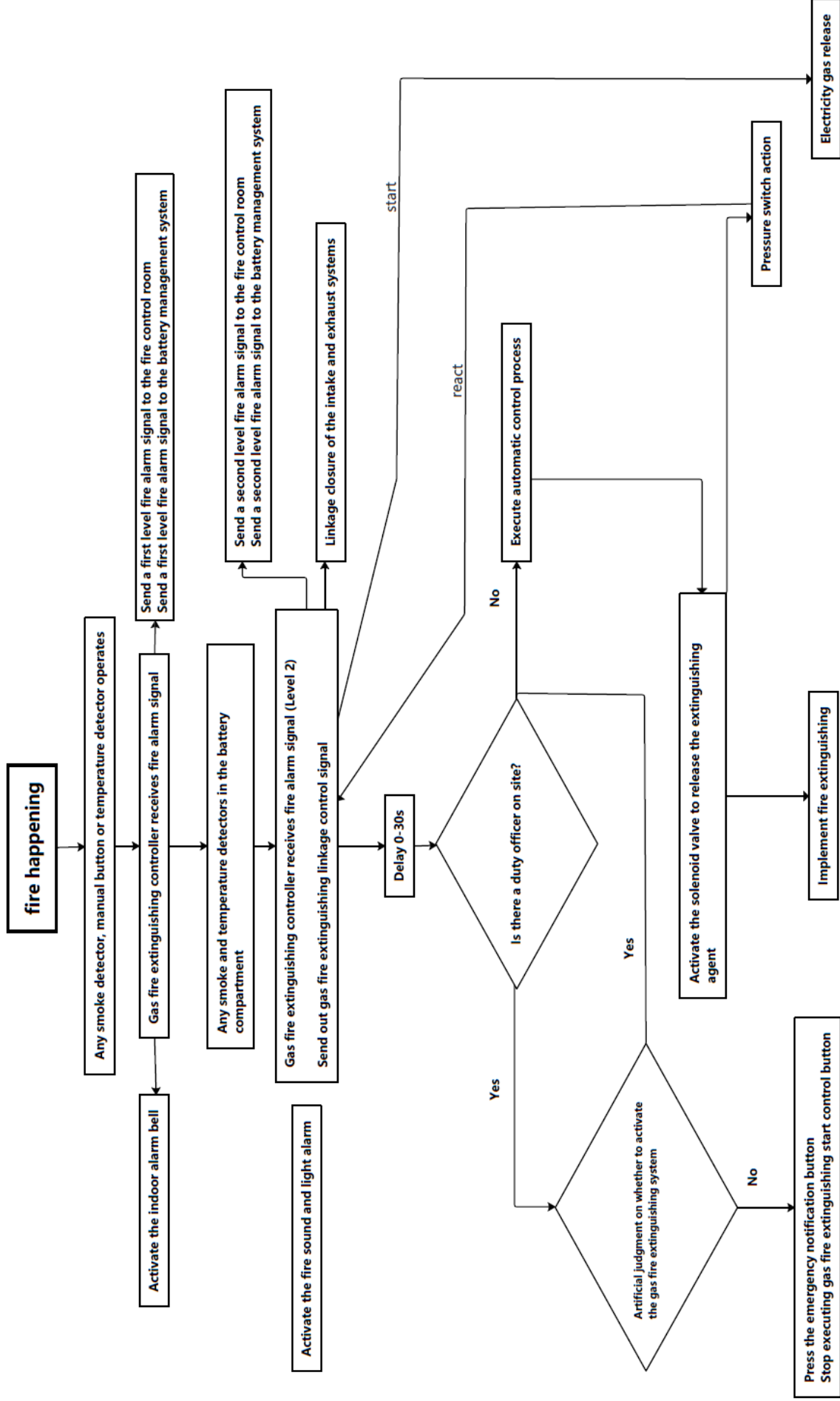

3.6.2 Fire Control Panel

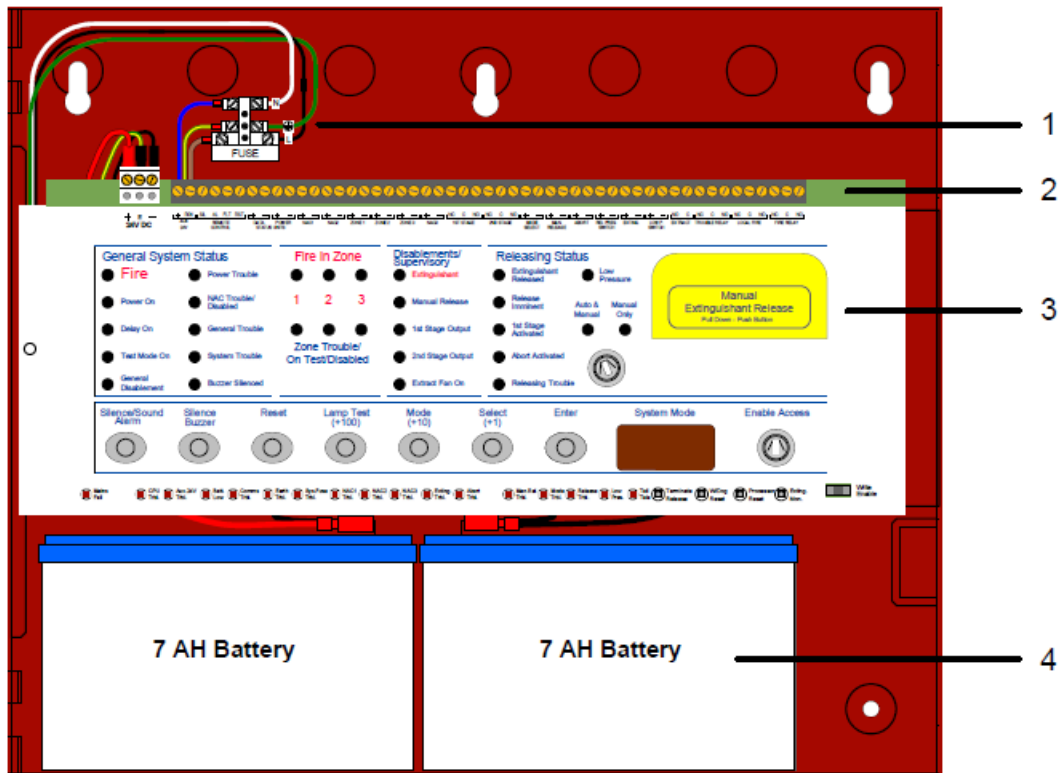

No.	Designation	Description
1	Mains Terminal Block	The Mains Terminal Block contains a 1.6 Amp fuse and accepts connections from the transformer primary and input power connections. Connections from the primary of the transformer to the Mains Terminal Block are pre-wired. Terminals of the Main Terminal Block are designated Line, Neutral and Ground.
2	Field Terminals	Field terminals provide connections for Zones, NACs, Releasing Devices, Relay Outputs, Status Units and AUX 24V.
3	Fascia	The front fascia of the Sigma A-XT Releasing Fire Control Panel is populated with controls and indicators for programming and operating the fire control panel.
4	Standby-Batteries	The Sigma A-XT Releasing Fire Control Panel contains two 12 VDC, 7 AH batteries for operating the fire control panel during primary AC power failure.

3.6.3 Gas detection and ventilation system

Gas detection system consists of combustible gas alarm controller, H2 detector, CO detector, and emergency start-stop switch for air intake and exhaust. The ventilation system consists of a fan control box, an explosion-proof fan, shutters and an air intake and exhaust emergency

start-stop button.

3.6.4 Sprinkler System

K=80 sprinkler is installed in the battery container, which is connected with DN65 Hose Coupling reserved outside the container through fire water supply pipe. In case of fire, fire water is provided by fire rescue water supply facilities.

3.7 Air Conditioning System

The system consists of six parts: internal circulation fan, external circulation fan, compressor, evaporator, condenser and control module. Ventilation is shown in the following figure:

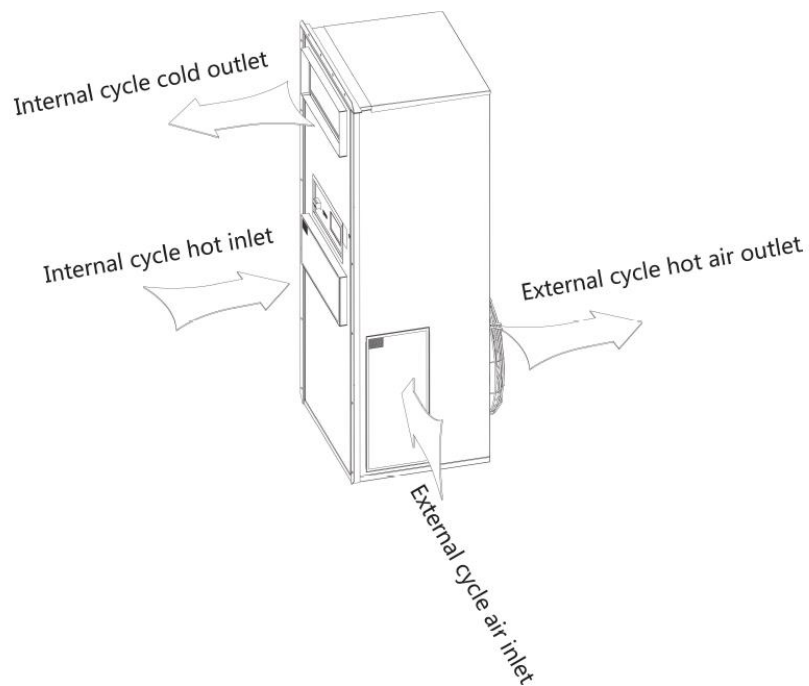

3.7.1 Main Interface

On the main page, pressing the left top corner can change the system language.



On the main page, press the start button on the lower left. When it is turned on, the machine status on the upper left will be changed from "standby" to "running". At the start state, press the start button at the main screen and the system is turned off.



3.7.2 Password Input Interface



Click "more" on the main menu and click "password input". Click the input box and enter the password.

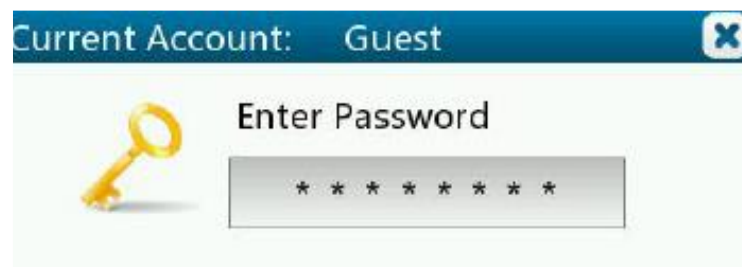

The password is "0001" by default, the user can change the temperature and humidity set point as well as temperature and humidity alarm point, check the alarm record and alarm history and the system operation status. If the user did not enter a password before entering parameters, it will automatically jump to the password interface when clicking on the corresponding parameters input box, and after the password is correctly entered, the parameters can be changed. It is

shown in the figure below.



3.7.3 Running State

The operating status includes: the current environmental state of the unit, the running state of the current unit, and the group control status of the current unit. Users can click on the upper of "system state" interface and click to view.



3.7.4 System Settings

The system settings include: time setting, temperature and humidity setting (option), String control configuration settings(option), account management settings (changing passwords).



All the setting modes are: click the corresponding input box, automatically jump out of the input keyboard and enter the desired

value. It is shown in the figure below.



4 System Installation

4.1 Installation Tools

 <p>Wire Cutter</p>	 <p>Crimping Modular Plier</p>	 <p>Cable Ties</p>
 <p>Screw Driver Set</p>	 <p>Electric Screw Driver</p>	 <p>1500V Insulating Gloves</p>
 <p>Adjustable Wrench</p>	 <p>Isolated Nut Drivers 1500V</p>	 <p>2000VDC Multimeter</p>
 <p>Anti-arc flash suit</p>	 <p>Goggles</p>	 <p>Safety shoes</p>

NOTE: Use properly insulated tools to prevent accidental electric shock or short circuits. If insulated tools are not available, cover the entire exposed metal surfaces with available insulated alternatives, except their tips, with electrical tape.

4.2 Hoisting

The system lifting point diagram is shown in the following figure.

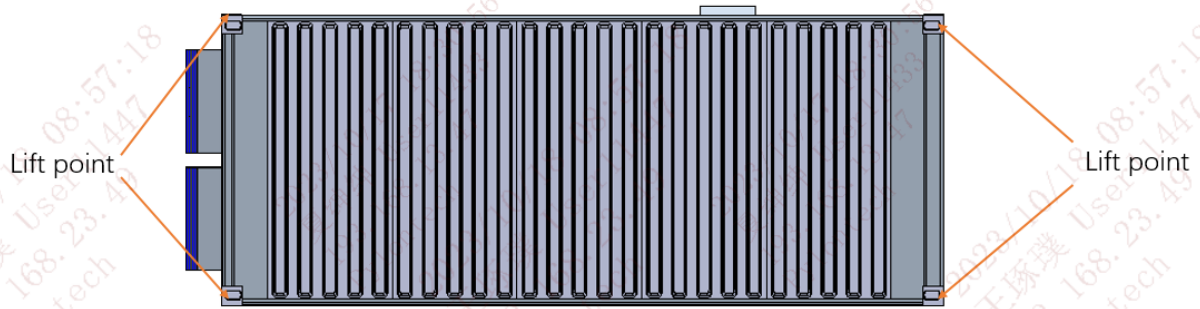

The schematic diagram of container lifting is shown in the figure. Please use cranes and spreaders greater than or equal to 35 tons for equipment lifting.

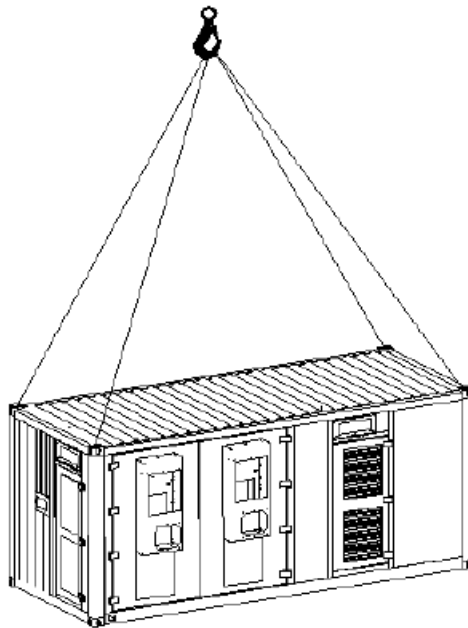

Danger: There is danger in hoisting, please follow the following requirements.

- During the whole process of lifting the equipment, all safety operation standards and specifications of the country where the project is located shall be strictly observed;
- It is forbidden to stand within 10m of the operation area, especially under the lifting arm and under the lifting or moving, to avoid casualties;
- In case of bad weather conditions, such as heavy rain, fog, strong wind, etc., the lifting work should be stopped.

NOTE:

- When lifting, the site safety must be ensured.

1. Set the fire protection to **Manual Only**, and the operation position is shown in the following figure.



Warning: If fire occurs during the installation and debugging of the system, please manually capture the Manual Extinguishant Release button. Otherwise, do not touch the Manual Extinguishant Release button to prevent equipment damage.



2. Open all the door and check all the detector without covering plastic.



3. After finishing the electrical installation and system commission (4.6-4.7 and 5.2) and there is no other alarm or fault on the system. Connect the and set the fire protection to the **Auto & Manual**.



4.6 Low-voltage Communication Installation

The MBMS interface is shown in the following figure.

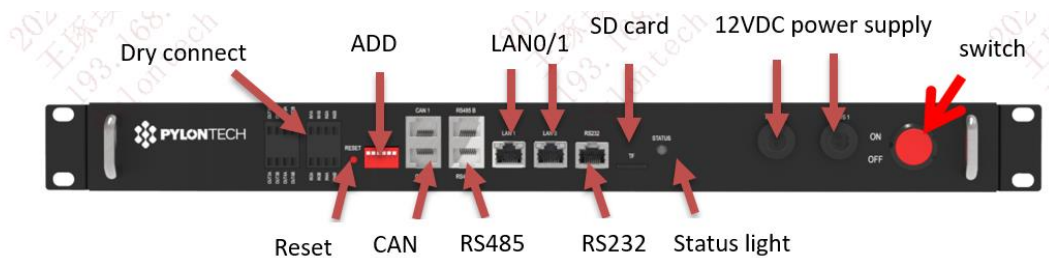

- Check the wiring according to the following table, and connect with CAN, 485 and dry contact of PCS during system installation.
- Check the wiring with reference to the following table, and connect with **LAN0 and 485** with EMS during system installation.

Serial number	Name	Sign	Function declaration
1	CAN communication port	CAN0	Communicate with the secondary master control
		CAN1	CAN protocol communication with PCS or EMS
2	RS485 communication port	RS485A/RS485B	Realizing modbus protocol communication with PCS or EMS (If the display is configured to use 485A communication)
3	Ethernet communication port	LAN1	Ethernet communication with PCS or EMS
		LAN0	Communication with secondary master control or switch
4	RS232 communication port	RS232	For local debugging
5	Status indicator	STATUS	Display the status of the main control module
6	power switch	ON/OFF	For opening/closing
7	Reset switch	Reset	Long press to restart the system
8	Code pulling switch	ADD	Master address dial switch
9	12Vdc power input port	Power S 1/2	Power input port
10	Dry contact	OUT1A/OUT1B OUT2A/OUT2B OUT3A/OUT3B OUT4A/OUT4B IN1A/IN1B IN2A/IN2B	Reserve 2 input and 4 output dry contact signals, which can be defined as required
11	memory card	TF	Used to save the historical data of the three-level master control

4.7 High-voltage Installation



Danger: When installing the power cable, it is necessary to ensure that the battery side relay and circuit breaker are all disconnected.



Danger: Please wear insulating gloves, shoes and goggles when installing cables.

4.7.1 Power Cables in the Cabinet

During transportation, each battery module in each string is disconnected, and the disconnection position is shown in the following figure: power terminal B- and power terminal B+.

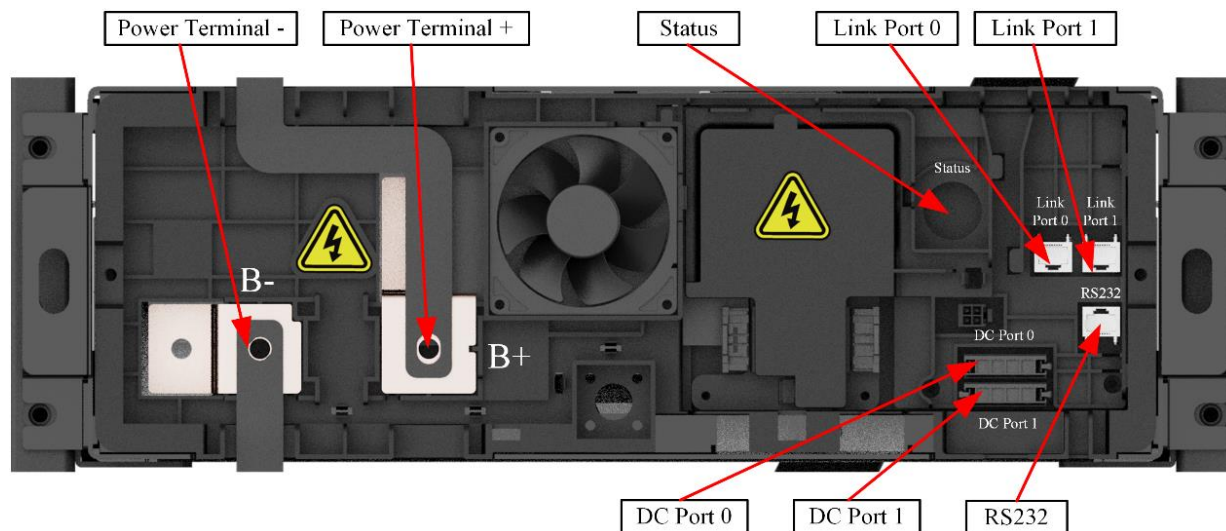

The cables need to be plugged when they arrive at the site. For details, please refer to the *PowerCube-M5A-180 Operation Manual*.

- The cable from the J-Box to the electrical cabinet has been installed at the factory. Please check the installation status of the cable when it arrives at the site, and use a multimeter to check the cable connection.

4.7.2 External Power Cable

The connection point between the DC side and PCS power wiring is shown in the following figure.

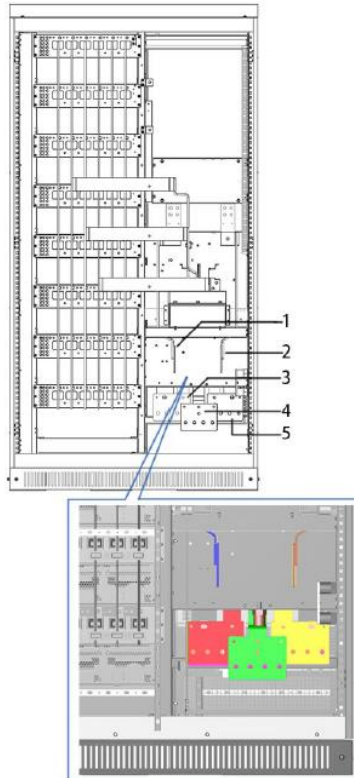

No.	Designation	Description
1	Battery -	Battery negative terminal
2	Battery +	Battery positive terminal
3	Grid C phase	C phase
4	Grid B phase	B phase
5	Grid A phase	A phase

1. Refer to the corresponding copper plate in the diagram for wiring and connect the Position 3,4,5 to grid phase A, B and C based on the table. The recommended torque is 70 Nm.

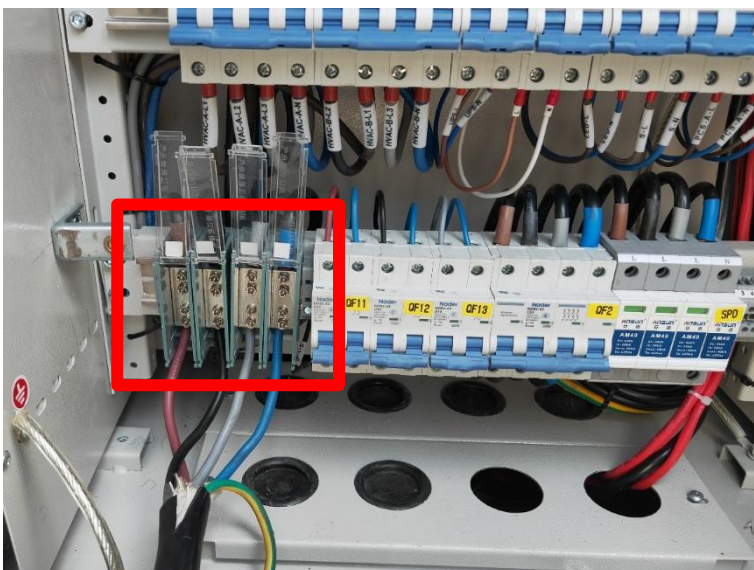

2. Tighten with screws on site, recommended torque is 6 Nm

4.8 HVAC Installation

4. Check the HVAC windshield in the following figure.



5. Find the 28 pcs screws are in the folder on the inner side of the electrical cabinet door.

6. Use the 28 pcs screws to fix the HVAC Windshield on the position shown in the following figure.



5 System Commission

5.1 System Status

Container system status

View system status through EMS monitoring screen.

String status

Status

Status LED: shows the battery module's status (RUN●, Alarm and Protection●).

SOC

Battery capacity indicators: 4 green lamps, each light represents 25% capacity.

Battery Status	Protection / Alarm / Normal	STATUS (green)	STATUS (red)	Capacity SOC				Descriptions
		●	●	●	●	●	●	
Shut Down		Off	Off	Off	Off	Off	Off	All off
Sleep	Normal	Flash 1	Off	Off	Off	Off	Off	Indicates Sleep Mode, to save the power.
Idle	Normal	Light	Off	Off	Off	Off	Off	Indicates save power mode.
	Alarm	Light	Off	Off	Off	Off	Off	Indicates the battery voltage or temperature is high or low.
	Protection	Off	Light	Off	Off	Off	Off	Indicates the battery voltage or temperature is over or under.
Charge	Normal	Light	Off	The highest capacity indicator LED flashes (Flash 1), others lighting.				The highest capacity indicator LED flashes (flash 2), others lighting, horse race lamp when SOC >= DODH;
	Alarm	Light	Off					
	Protection	Off	Light	Off	Off	Off	Off	Stop charging, STATUS(red) lighting
Discharge	Normal	Flash 1	Off	Indicate based on capacity				Indicate based on capacity
	Alarm	Flash 1	Off					
	Protection	Off	Light	Off	Off	Off	Off	Stop discharging, STATUS(red) lighting
Abnormal	Power On Fault	Off	Flash 2	Off	Off	Off	Off	Stop charging/discharging, STATUS(red) lighting
	Other Fault	Off	light	Off	Off	Off	Off	

	STL Fault	Off	Flash 1	Flash 1	MCU self-check problem
--	-----------	-----	------------	---------	------------------------

The flashing instructions:

Flash 1 - 0.5 s light / 0.5 s off;

Flash 2 - 1 s light / 1 s off.

5.2 System Startup



Warning: Double check all the power cables and communication cables. Make sure the PCS voltage matches the battery system voltage. Check all the power switches of each battery system are OFF.



Warning: MBMS must be switched on **AFTER** all battery strings finish self-check.



Warning: The external switches or breakers between PCS and battery string must be off before the battery system power on.

Precondition

- Ensure that all micro circuit breaker in the electrical cabinet are off.
- Ensure that the AC switch and DC switch of PCS are off.

Procedure

1. Connect the external power supply and set the inlet circuit breaker on.
2. Set all micro circuit breakers in the electrical cabinet on and check if the fire fighting host and air conditioning system are powered on successfully.
3. Please follow the UPS part in **Section 3.4 Electrical Cabinet**. Check the UPS (if configured) is switched on. And the UPS is supplying power.
4. Make sure the MBMS is **off**.



5. Switch on all the BMSs (Battery Control Modules) as following steps.

Switch on the 1st BMS (Battery Control Modules) of battery string.

NOTE: The second BMS must be operated after the first battery string's self-check succeeds, which should be done within 30 seconds. Switch on the battery strings one by one from the first BMS to the last one.

Description of switching on the BMS is as follows:

- (1) Switch on the "Power Switch" and "Fan Switch" of the BMS

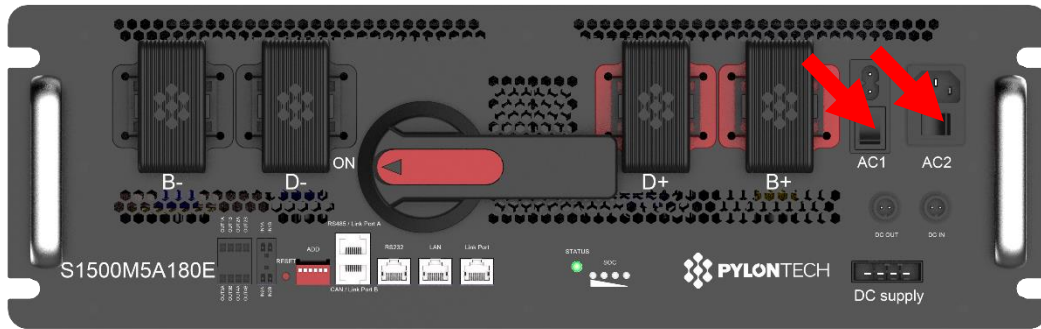

(2) System start process.

The battery string's system will enter self-check mode once the system is power on.

If the BMS and all battery modules are working normally, every status LED will light green. That means self-check is completed, which should be done within 30 seconds. But if the BMS can't receive signals from upper-level device (MBMS), the "STATUS" LED will light red after 30 seconds. That doesn't mean there's a failure, referring to Instructions of the self-check process as below.



Warning: If there is any failure during the self-check, be sure to debug the failure prior to next step.

Instructions of the self-check process:

The status LEDs on the BMS and battery modules show green: if the BMS and all battery modules are working properly and the self-check is completed within 30 seconds, each status LED shows green, indicating that the self-check is finished.

The status LED on the BMS turns red after 30 seconds: the BMS cannot receive signals from the upper-level device (MBMS) because of the communication outage. Then the status LED will turn red after 30 seconds. This does not mean that there is a failure, it is that the BMS is not communicating with the MBMS/PCS/EMS and the relay is open.

The status LED on the BMS or battery module shows red from the beginning: if the status LED shows red from the beginning, it indicates that there is a failure of the battery. And the relay of the BMS will be open. In this case, inspection of the battery module must be performed first.

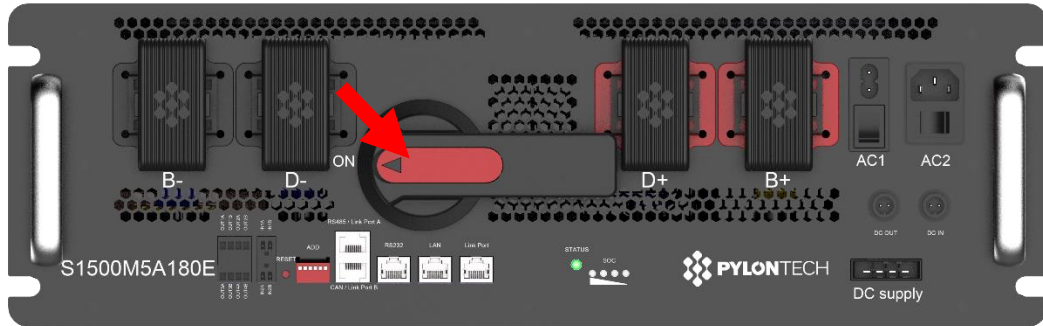

6. Switch on the MBMS and after all the BMSs are turned on. The "STATUS" LED will light green.



The Power Relays in BMS will be close automatically after 3 minutes' self-check of MBMS. The "STATUS" LED of the BMS will light green.

The MBMS will firstly close the relay of the minimum voltage battery string and the battery string(s) within 5VDC voltage difference to the minimum voltage battery string. In this situation, please make a full charge of the BESS and during the process, each string will be in parallel connect one by one.

NOTE: External device (PCS, EMS, etc.) should communicate with BESS through LAN, CAN or RS485. Otherwise the battery system will work abnormally.



Caution: The whole Battery Energy Storage System (BESS) should be charged to full at first before commercial operation, or after it is left unused for a long time.

7. Turn on all the "circuit breaker" of S1500M5A180E.
8. Turn on the Auxiliary power switch and surge protector switch shown in the following figure.

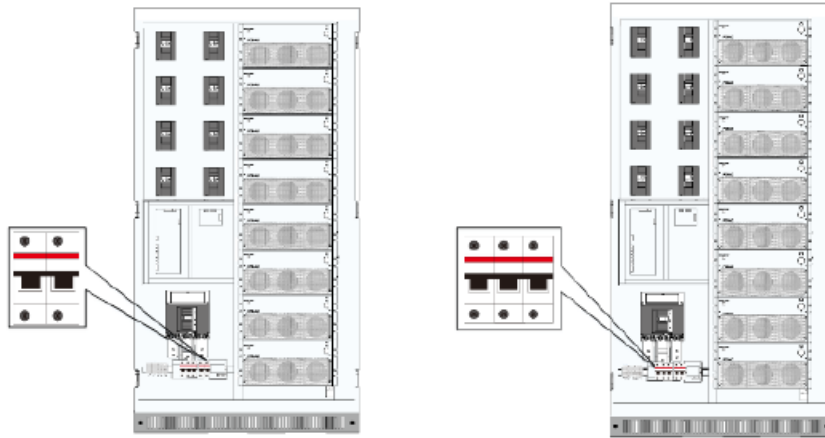

9. Set the AC switch to the "I" position on the PCS side.

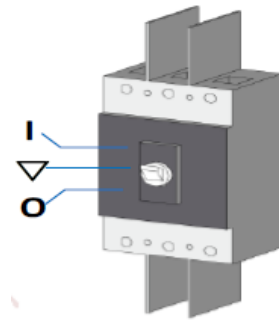

10. Set the battery DC branch switch to the "I" position on the PCS side.

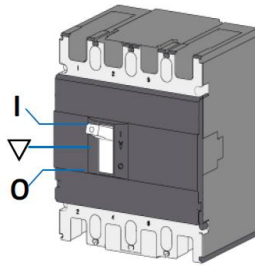

NOTE: When starting up for the first time, it is necessary to fully charge for SOC calibration.

After installing or restarting the system when it is not used for a long time, the entire energy storage system should be firstly fully charged.

5.3 System Shutdown

During maintenance or long-term storage, be sure to power off the battery system:

1. Please disconnect the AC switch of the PCS and disconnect the DC switch to ensure no current flows through the battery pack.
2. Open the Auxiliary power switch and surge protector switch in PCS cabinet.
3. Turn off the "Power Switch" of the MBMS. If the BESS configures only single battery without MBMS, then this step is not needed.
4. Turn off the Ethernet Switch [If configured].



5. Set the circuit breaker for S1500M5A180E off.

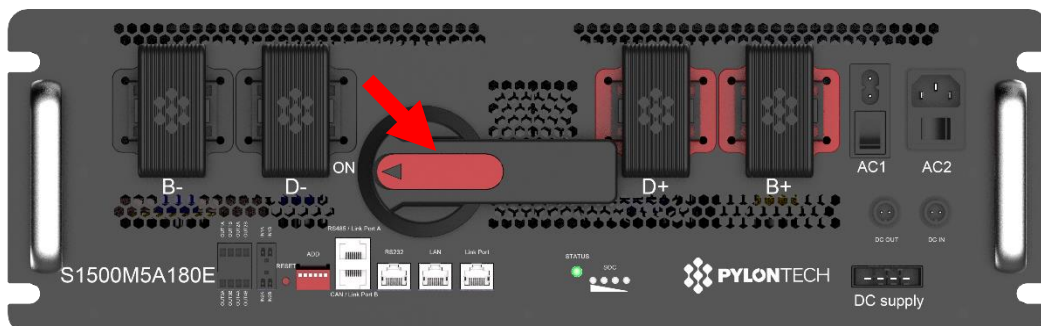

6. Turn off the "Power Switch" (AC1) and "Fan Switch" (AC2) of the BMS.

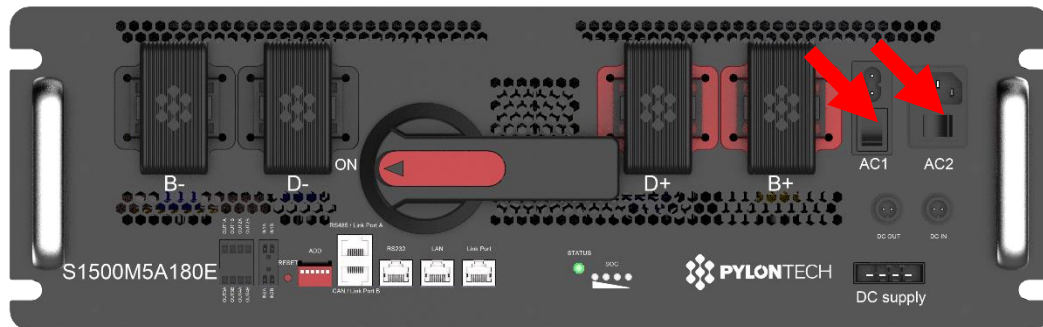

7. Turn off the UPS (if configured) if the system will be shut down for a long time (≥ 3 days).

Or, Keep the UPS on (if configured) if the system will be shut down less than 3 days.

8. Set all micro circuit breakers off in the electrical cabinet if the system will be shut down for a long time (≥ 3 days).

Note: Set the micro circuit breakers off in the electrical cabinet except UPS micro circuit breaker if the system will be shut down for less than 3 days.



Caution: The UPS can be powered on if there exists any equipment that needs working without power outage. Otherwise the UPS must be turned off to save its power.



Caution: Before changing the battery module for service, be sure to charge/discharge the replaced battery at the same open circuit voltage as the other ones in the battery module system. Otherwise the system needs long time to do balance for this new battery module.



Warning: Do not turn off the "Isolating Switch" or "Circuit breaker" during normal running status (unless emergency situation). Otherwise it will cause current surge to the rest battery strings. Be sure to turn off the PCS first prior to turning off the "Isolating Switch" or "Circuit breaker" in normal running condition.

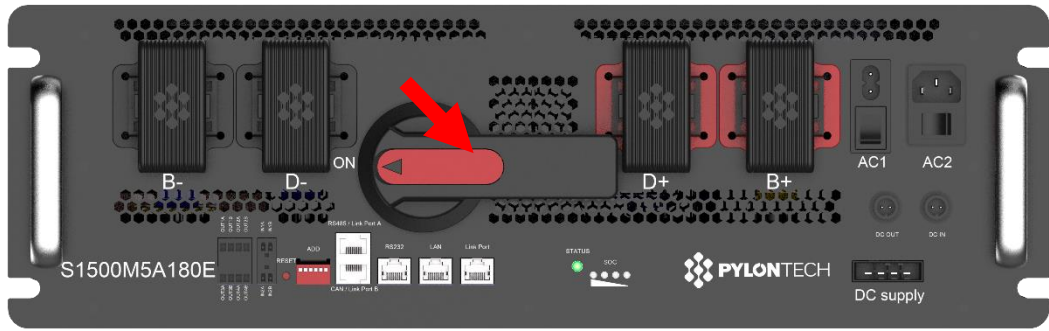



Warning: Do not turn off the "Power Switch" and "fan switch" during normal running status. Otherwise it will cause the DC relay of this BMS adhesion this battery string, and current surge to rest battery strings. Be sure to turn off the PCS first prior to turning off the "Power Switch" and "fan switch" in normal running status.

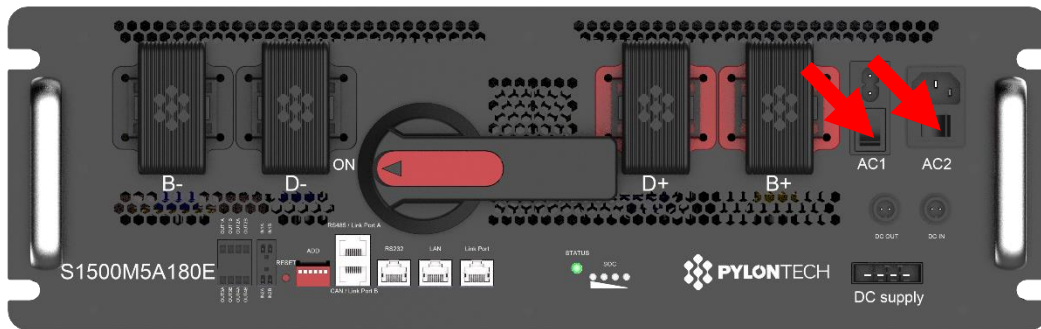

NOTE: After installation, do not forget to register online for full warranty: www.pylontech.co.cn/service/support

6 Maintenance



Danger: The system is a high voltage DC system, operated by qualified and authorized personnel only.



Danger: Before checking the failure, be sure to check if all the cable connections are correct and if the BESS can turn on normally.

6.1 Trouble Shooting

The common faults and solutions during the commissioning of the energy storage system are shown in the following sections. If the problems cannot be solved according to this manual, please contact us. We need the following to help you better.

- Machine serial number, production date and software version
- Manufacturer, model and configuration information of the equipment
- Simple fault description
- Failure site photos

6.1.1 System Troubleshooting

Local monitoring checks the fault trigger location, which is divided into battery string fault, fire fault and air conditioning fault.

6.1.2 Battery String Failure

- Use a 232 to USB device to connect to the on-site PC, and at the same time, contact the after-sales engineer of Pylontech to obtain the CRT software and install the software;
- Connect RJ45 port to the 232 debugging port of the corresponding fault master, and connect USB port to the PC end of the computer. Open the control panel to read the port number, and select the port number of the software as the corresponding serial port;
- Connect the computer to WIFI or network and install sunflower remote software, opening the Batteryview debug APP;
- Contact the dispatched after-sales engineer for troubleshooting.

6.1.3 Fire Fighting Failure

No.	Fault name	Checking method
1	Power Failure	There is no 230V AC power supply, and the system operates using backup batteries. If there is no power outage, or check the electrical fuse inside the panel.
2	Battery failure	Check if the two batteries are connected and connected together, Test the battery. Disconnect the battery and ensure that 28 volts can be measured on the battery charger lead.
3	Auxiliary 24V fault	The LED light indicates that the fuse protecting the R0V output has been activated and exceeds the rated value of the output.
4	Communication fault	Communication interruption between relay panels or accessory boards. Check all communication faults between repeaters and auxiliary boards to determine the root cause of the problem.
5	Manual release fault	Manual release switch input short circuit or open circuit. Remove the wiring and reinstall the end of the line. Check the wiring of the manual release circuit.
6	Release fault	Release switch input short circuit or open circuit. Remove the line and reinstall the end of the line. Check the wiring of the release pressure switch circuit.

If other faults occur, please contact the suppliers.

6.1.4 Air Conditioner Failure

Fan fault

Table 6-1: Fan faults and recovery measures

Symptom	Possible cause	Check items or processing method
Internal cycling fan cannot run	No electricity	Check whether the input terminal of the air conditioning power supply is
	Power supply is abnormal, over-voltage protection/low-voltage protection and phase sequence	Through the RS485 communication or the connection of the external display, determine whether the presence of air conditioning corresponding alarm.
	Air conditioner is in the standby state.	It is a normal case ,air conditioner will get into the automatic control logic after being power on and in the
	The fan gets stuck	Check if there is any foreign object that blocks the fan
	The terminal is	Check if the fan connecting terminal is
External cycling fan cannot run	The compressor is not started.	The outside fan can run after the compressor starts.
	The fan gets stuck	Check if there is any foreign object that blocks the fan
	The terminal is	Check if the fan connecting terminal is
Fan makes abnormal noise	The bearing of	Replace the fan.(Refer to Figure 6-2)
	The blades of fan scratch other	Check whether there are any interferences between the cable and
The external hydrogen discharge fan does not work	Setting error or the operating condition has	Check if the operating condition is satisfied.
	Power cut-off	Check the external power supply.
	The fan cannot	Replace the fan. (Refer to Figure 6-3)
	The default is not opened	Make sure whether there is an external fan linkage function configuration.

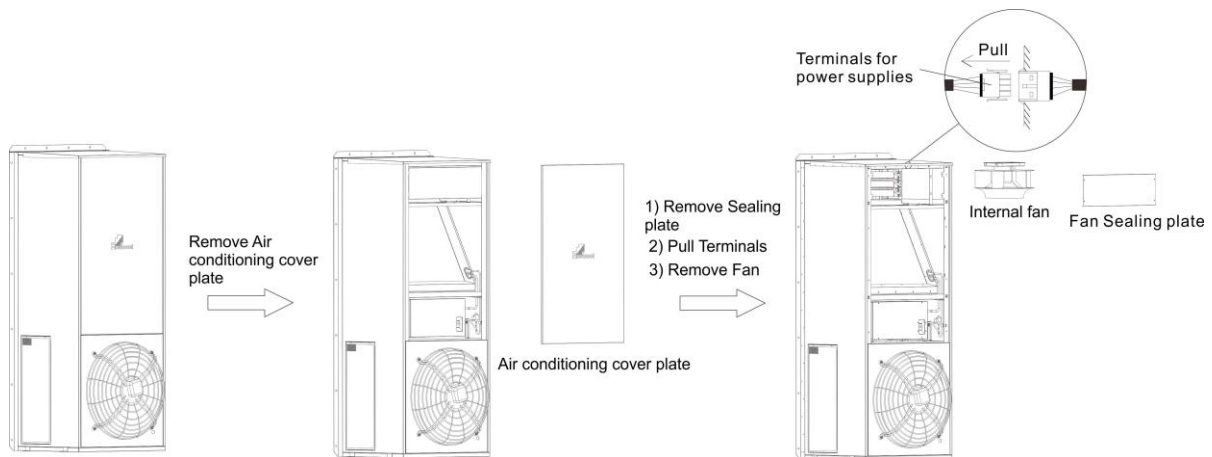

Fig. 6-1: Schematic diagram for remove the internal fan

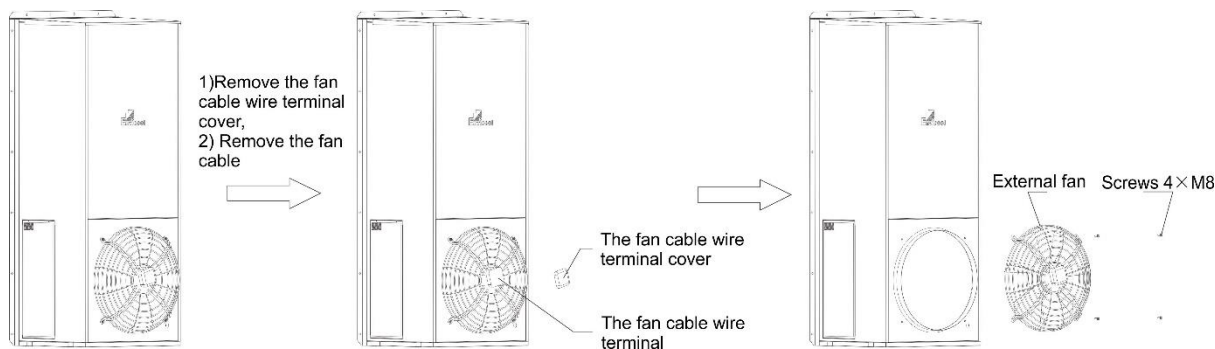

Fig. 6-2: Schematic diagram for remove the external fan

Cooling system failure

Table 6-2 Cooling system faults and recovery measures

Symptom	Possible cause	Check items or processing method
The compressor cannot start	The power supply is not started	Check the main power switch, and check if the startup interface is
	Loose circuit connection	Tighten the circuit connectors.
	The compressor motor burns out	Check the motor and replace it if any defect is found.
The compressor cannot work	There is no cooling demand	Check the display of the internal cycle temperature and the compressor output status on the operation interface
	Within shutdown delay	The compressor has the shortest shutdown time in normal state. If the temperature rises to the starting point during this period, the compressor still would not start
High discharge pressure	The condenser is clogged by dirt	Clean the condenser.
	The condenser fan does not work	Refer to Table 6-1.
The evaporator freeze up	The internal circulation fan is	Refer to Table 6-1.
	The capillary temperature sensor can not work	Check whether the connection is normal ,if not ,replace the capillary temperature sensor.

6.2 Emergency Disposal

The container emergency stop and fire fighting operation modes are shown in the following figure.



The bottom is the emergency stop button (EPO), and the top is the fire control, including manual and automatic switching, audible and visual alarm, gas discharge indicator light, and fire extinguisher release alarm light.

6.2.1 EPO

In case of fire or any situation beyond the control of anyone, please immediately snap the emergency stop button to stop the system. Do not touch the EPO during normal operation. To restore the system, first rotate the EPO button in the operating direction on the panel to make the button pop up, and then power on the system according to the power on steps.

6.2.2 Fire Fighting Equipment



Warning: Do not operate the fire-fighting equipment when the system is free of fire, which may cause the system to fail to operate normally later

In case of fire in the system, the fire protection system will spray automatically. If the fire protection system does not act, please operate the fire emergency starting device for active fire protection. The emergency starting device is shown in the figure below.



6.3 Routine Maintenance

Due to the influence of ambient temperature, humidity, dust, vibration, etc., the internal components of the system or equipment will be aged or worn, which will lead to the potential failure of the system or equipment. Therefore, it is necessary to carry out routine and regular maintenance on the system to ensure its normal operation and service life.



Warning: Only qualified and authorized personnel can maintain the system. During maintenance, do not leave screws, washers, tools and other metal parts inside the equipment, otherwise the equipment may be damaged.



Warning: After the system is out of operation, you must wait at least 10 minutes before carrying out maintenance or overhaul operations on the system. After the system is shut down, pay attention to:

- Ensure that the system is not accidentally re powered on.
- Use a multi-meter or a stylus to check to ensure that the system is completely dead.
- The possible live parts adjacent to the operating part shall be covered with insulating cloth.
- During the whole process of maintenance and overhaul, it is necessary to ensure that the escape routes are completely unblocked.

Precondition

- set the fire protection to **Manual Only**.



- Remove the Solenoid valve.

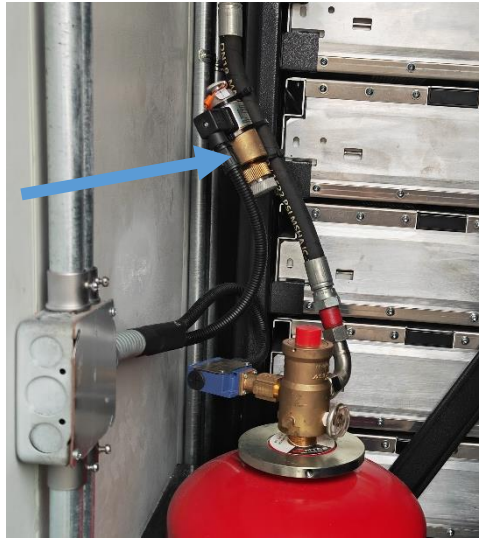

Routine maintenance

The regular maintenance plan is formulated according to different equipment. Please refer to the following table and the recommended cycle for maintenance:

Project	Standard	Frequency
Battery string hardware	Whether the LED light on the main control box displays normally	half a year
	Whether the relay inside the main control box can be disconnected normally	half a year
	Whether the LED on the battery pack displays normally	half a year
	Is there abnormal sound or abnormal operation of the battery string fan?	half a year
container	Check whether there are signs of aging and burning at the wiring bolts of the battery and the electric cabinet, and shake them by hand to make sure that they are in a tight state;	one year
	Check the power cable and control cable for signs of broken skin. If there are any signs, it is necessary to add corresponding insulation measures or replace cables.	one year
	Check the connector for looseness, serious rust or oxidation on the terminal surface, and good contact.	one year
	Is the grounding point loose?	one year
air conditioner	PCS and containers should be cleaned or replaced with air filters to increase the air volume at the air inlet.	one year
	Check whether the air conditioner refrigerant is sufficient and replenish the refrigerant.	half a year

Fire fighting maintenance items and frequency

Project	Standard	Method	Frequency
Fire fighting system	Fire protection system linkage testing	Conduct fire system linkage testing	one year
	Bleed indicator light	Pull up pressure switch reset button	one year
	Smoke and temperature detectors, alarm bells	Use a fire test smoke temperature gun. If the smoke does not exceed the preset alarm value, the indicator light flashes once every 6 seconds; If the smoke exceeds the preset alarm value, stable indicator light on, fire extinguishing controller generates an alarm and triggers an alarm bell	one year
	Audible and visual alarm	Press the manual release button on the control panel.	one year
	UPS on the control board	Disconnect the power input from the control panel and allow the rear battery to power the control panel.	one year

Cause and Effect Matrix for M Series ESS Container Products

Information Version: V1.0

System Output System Input	Notification			Action				Output signal				
	Bell Alarm	Horn Strobe Alarm	Gas Release Indicator LED Action	Agent Release Countdown Starts	Agent Release Countdown Pauses	Agent Release Countdown ends	Ventilation Operation	Ventilation Shutdown	Fire Alarm	Agent Release Signal	General Fault	Gas Detector Signal
Description	A	B	C	D	E	F	G	H	I	J	k	L
Smoke detector alarm x 1	√								√			
Heat detector alarm x 1	√								√			
Smoke detector alarm x 2	√								√			
Heat detector alarm x 2	√								√			
Smoke and heat detector alarm	√	√	√	√		√		√	√	√		
Manual pull station action	√	√	√	√		√		√	√	√		
Pressing and holding abort station button					√							
Any fault of fire control panel											√	
H2 detector action							√					√
CO detector action							√					√

NOTE: See the reverse of this page for detailed instructions.

Instructions of the System Output Items (A~L)

Item	Instructions
A	Bell releasing alarm indicates a potential fire hazard.
B	Horn strobe releasing alarm indicates that fire extinguishing agents are to be released.
C	Gas release indicator LED lighting indicates not entering the space where fire extinguishing agents are to be
D	The countdown of agent releasing starts, and countdown period can be adjusted from 0 to 30 seconds.
E	The countdown of agent releasing is paused at 10 seconds by pressing and holding the abort station button.

F	The countdown of releasing agent has ended, and the agent has been released into the container.
G	The explosion-proof ventilation device operates to reduce the amount of combustible gas in the container to a
H	Before agent releasing, turn off the ventilation device to prevent the agent from leaking.
I	Output dry contact signals of external device and host.



PYLONTECH

Pylon Technologies Co., Ltd.

5/F, No.71-72, Lane 887, ZuChongzhi Road, China (Shanghai) Pilot Free
Trade Zone

Pudong, Shanghai 201203, China

T+86-21-51317699 | **F**+86-21-51317698

E service@pylontech.com.cn

W www.pylontech.com